

SPECIFICATIONS / TECHNICAL DATA

PHOENIX

VANITY COLLECTION

48"

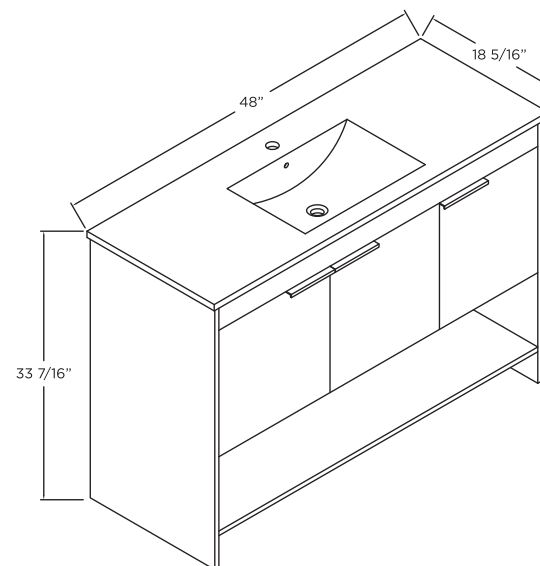
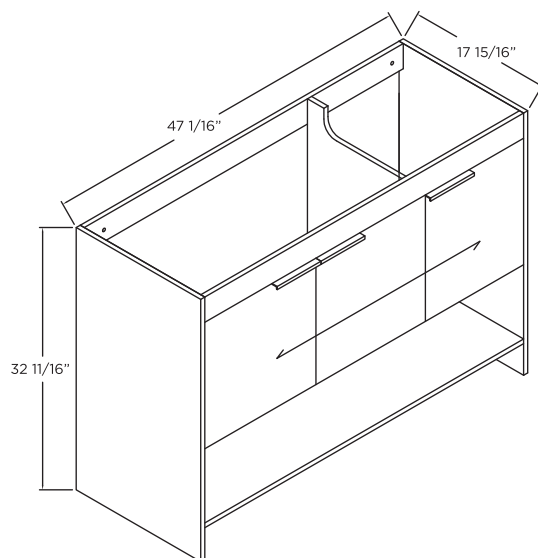
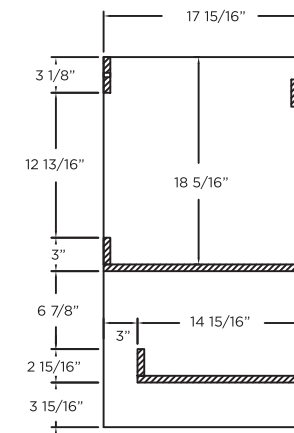
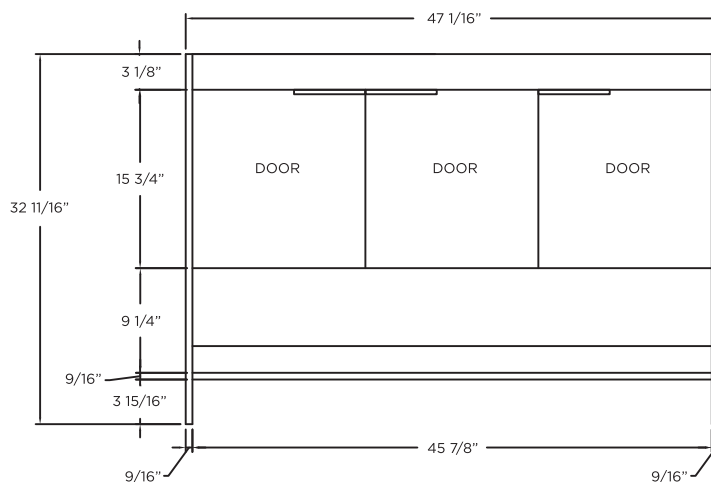

ATTENTION! Dimensions may vary by up to 3/8". It is highly recommended to pull all dimensions of actual model for installation and measuring purposes.

MODEL# PH48